

L120CWG1KN

Super Green

3mm, Flanged Cylindrical, 4.5mm Height
45° viewing angle

DWG BY:
BL / GP
10-12-06

CHK BY:
PL
10-24-06

QA:
10-__-06

MFG:
__-__-__

REVISION LTR: -
10-24-06

● **Features:**

1. Chip material: AlGaInP/GaAs
2. Emitted color : Super Green
3. Lens Appearance : Water Clear
4. Low power consumption.
5. High efficiency.
6. Versatile mounting on P.C. Board or panel.
7. Low current requirement.
8. 3mm diameter package.
9. This product is RoHS compliant.

● **Applications:**

1. TV set
2. Monitor
3. Telephone
4. Computer
5. Circuit board

● **Package dimensions**

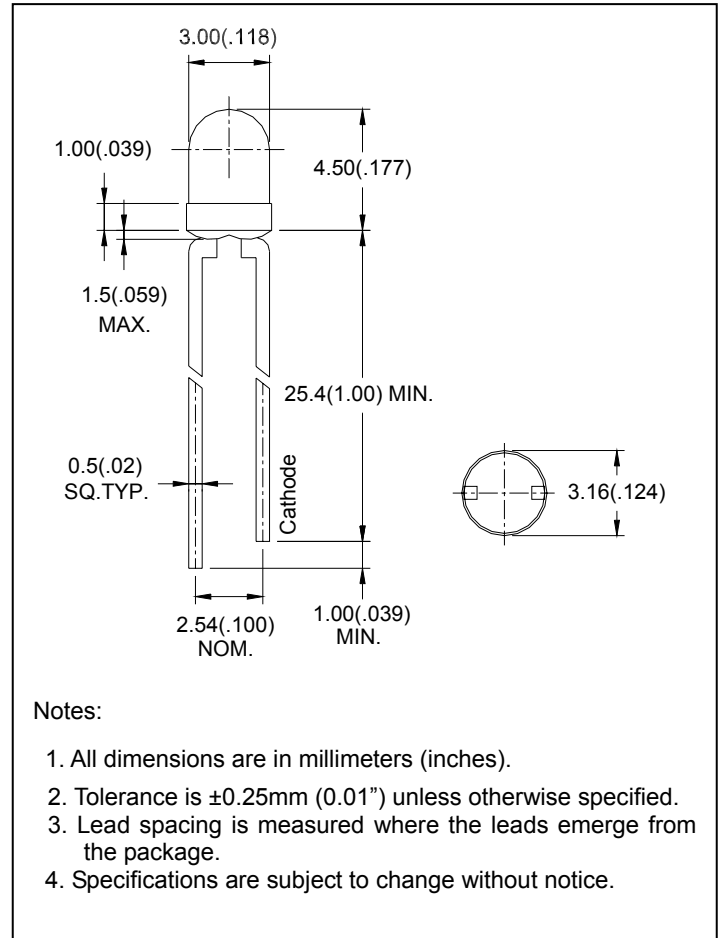

● **Absolute Maximum Ratings(Ta=25°C)**

Parameter	Symbol	Rating	Unit
Power Dissipation	Pd	100	mW
Forward Current	I _F	30	mA
Peak Forward Current ^{*1}	I _{FP}	150	mA
Reverse Voltage	V _R	5	V
Operating Temperature	Topr	-40°C~80°C	
Storage Temperature	Tstg	-40°C~85°C	
Soldering Temperature	Tsol	260°C (for 5 seconds)	

*1Condition for I_{FP} is pulse of 1/10 duty and 0.1msec width.

● **Electrical and optical characteristics(Ta=25°C)**

Parameter	Symbol	Condition	Min.	Typ.	Max.	Unit
Forward Voltage	V _F	I _F =20mA	-	2.0	2.6	V
Luminous Intensity	I _v	I _F =20mA	-	325	-	mcd
Reverse Current	I _R	V _R =5V	-	-	100	μA
Peak Wave Length	λ _p	I _F =20mA	-	574	-	nm
Dominant Wave Length	λ _d	I _F =20mA	-	573	-	nm
Spectral Line Half-width	Δλ	I _F =20mA	-	18	-	nm
Viewing Angle	2θ _{1/2}	I _F =20mA	-	45	-	deg
Radiant Intensity		I _F =20mA	-	-	-	μW/sr
Chromaticity Coordinates	X	I _F =20mA	-	0.46	-	
	Y		-	0.53	-	

● **Typical electro-optical characteristics curves**

Fig.1 Relative intensity vs. Wavelength

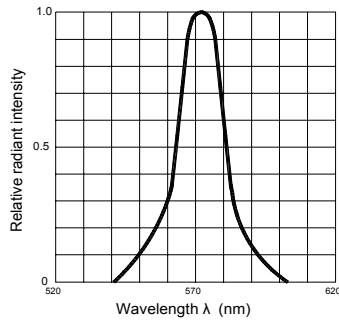

Fig.2 Forward current derating curve vs. Ambient temperature

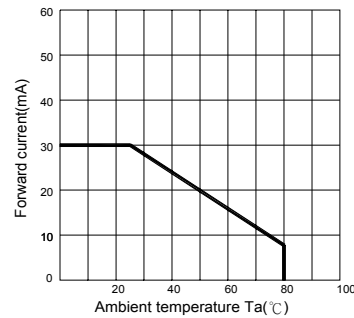

Fig.3 Forward current vs. Forward voltage

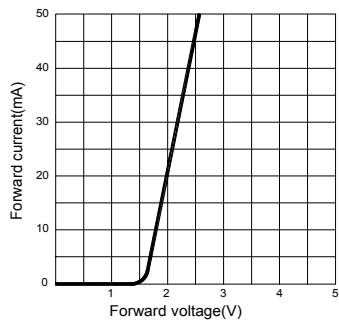

Fig.4 Relative luminous intensity vs. Ambient temperature

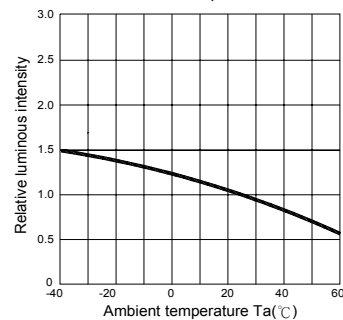

Fig.5 Relative luminous intensity vs. Forward current

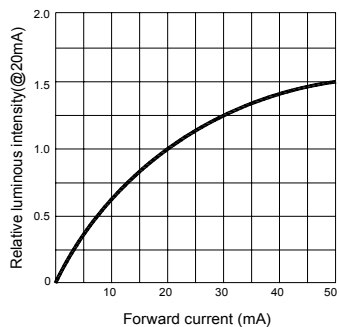
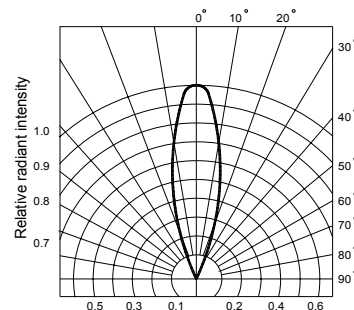

Fig.6 Radiation diagram



● **Bin Limits**

1. Intensity bin limits (At $I_F = 20\text{mA}$)

Bin Code	Min. (mcd)	Max. (mcd)
:	:	:
S	180	360
T	280	550
U	410	820
V	620	1230
W	930	1840
:	:	:

2. Color Bin Limits (At $I_F = 20\text{mA}$) : Dominant Wave Length $\lambda_d(\text{nm})$

Bin Code	Min. (nm)	Max. (nm)
4	565	569
5	567	571
6	569	573
7	571	575
8	573	577
9	575	579

